

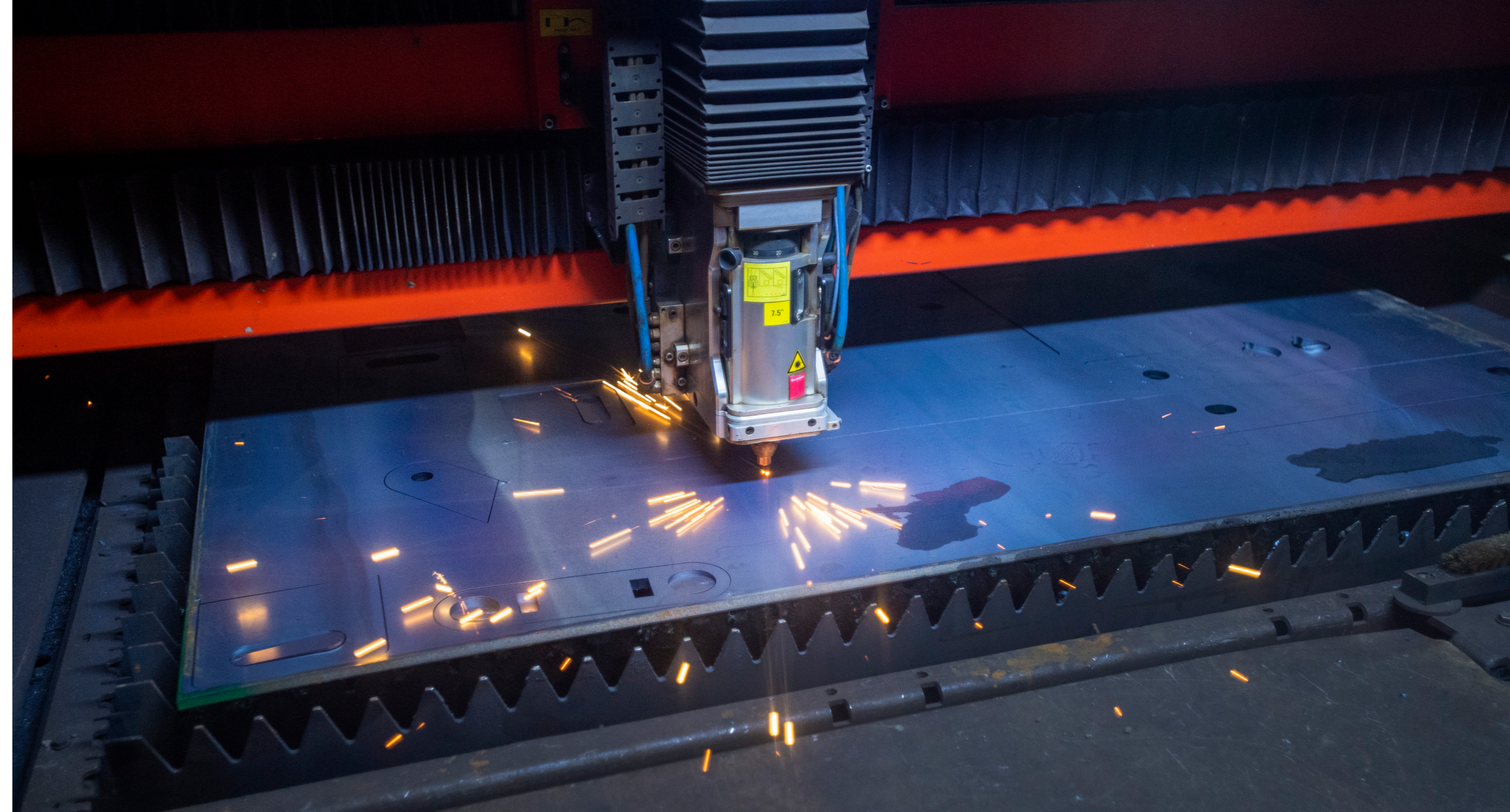

work safely





Catalogue valid as of 16/10/2023. Please quote name and catalogue number when ordering. The images in the catalogue may differ from the product on sale. The photos may include additional options which are not included in the standard equipment.

Inter Tech reserves the right to change technical parameters and other physical characteristics. Inter Tech reserves the right to make changes to the products without informing the customer. The weights given are approximate and may differ from the actual weight depending on equipment and configuration. The catalogue is for information purposes only and does not constitute a commercial offer within the meaning of Article 543 of the Civil Code. The General Terms and Conditions of Sale (GTS) are available on the Inter Tech website www.intertech-agro.pl.

Mission



Fusion of passion, knowledge, commitment in an ever-changing world.



Vision

We are the company that best in agribusiness YESes care of relationships according to individual customer needs.



Courage

- Boldness and openness
- Determination
- Commitment and passion for common goals



Development

- Emphasis on innovation
- Development of skills and knowledge
- Searching for better and better solutions, meeting customers by constantly improving quality.



Partnership

- Human First
- Building lasting relationships
- Commitment

We are intensively developing the sales segment and new products and services. We are adapting our business profile to be fully customer-focused. The values reflect the way Inter Tech wants to achieve its goals. The essence of the Human First partnership is customer focus, building lasting relationships and commitment. We actively increase the potential of new products through the fusion of modern contact channels and compatible services. Development means an emphasis on innovation, development of skills and knowledge and the search for ever better solutions, meeting customers by constantly improving quality. Courage means boldness and openness, determination as well as commitment and passion in achieving common goals. The combination of these values leads to a better understanding of customer expectations, allows us to respond to market challenges and strengthens the Inter Tech Family's corporate culture.

Inter Tech Family

A fusion of passion, knowledge, commitment in an ever-changing world.

We have nothing to hide. Inter Tech is more than a company.

It is a community where everyone is treated like a family member.

There are few family businesses that build a lasting foundation in international relationships having a significant impact on agricultural development.

Inter Tech Family is the ideal place for ambitious, enthusiastic people looking for inspiration in their development, for whom gaining professional experience is a great motivation for work and a source of satisfaction.

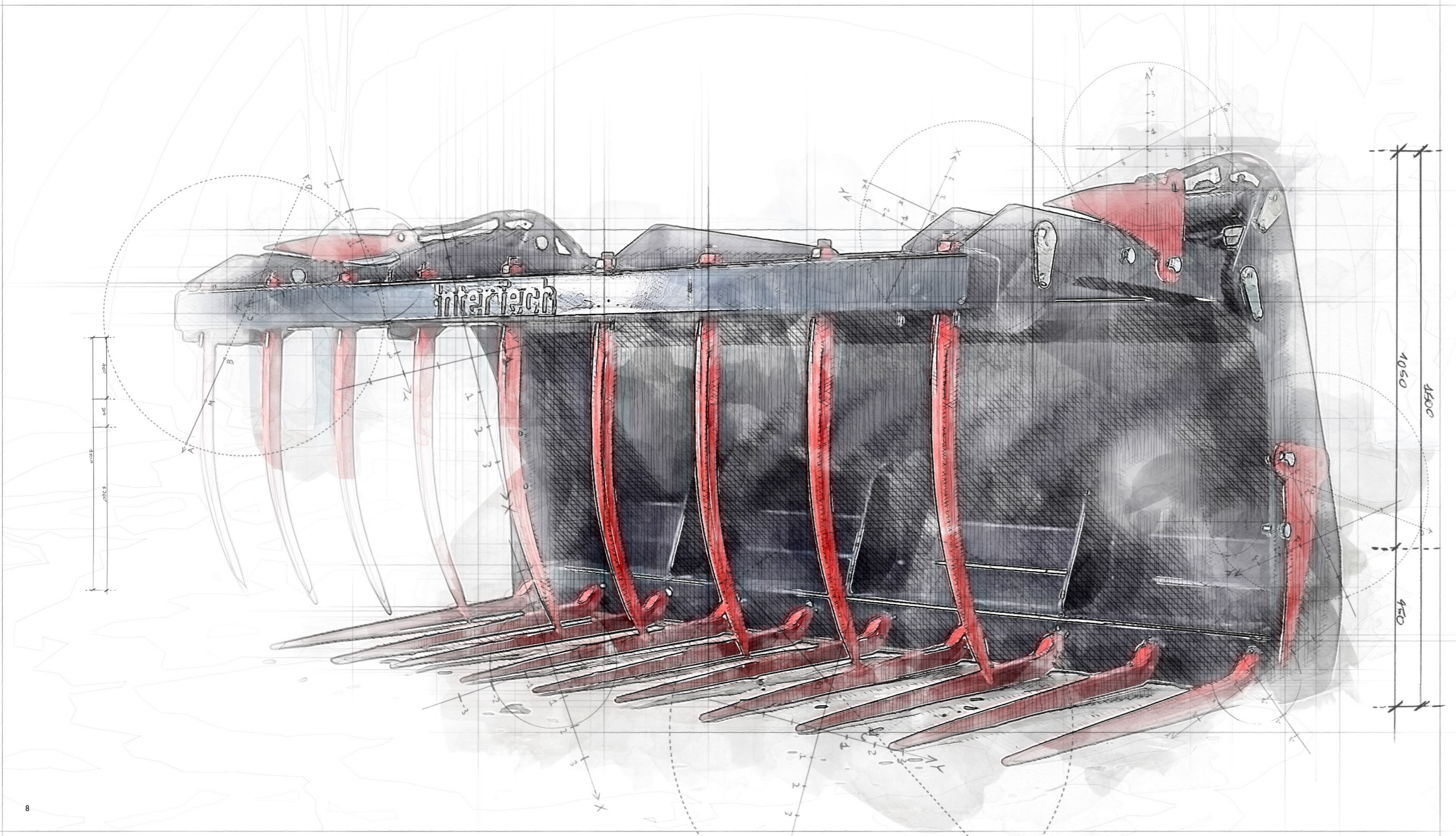

Smart Line

Smart means diverse

We are aware of the difficult and unpredictable conditions in which farmers work.

Time and precision of action play a key role in managing farms. The quantity and diversity of daily tasks mean that they often need reliable equipment to increase the efficiency of their work.

The choice of accompanying machines that they can make will improve and facilitate their work.

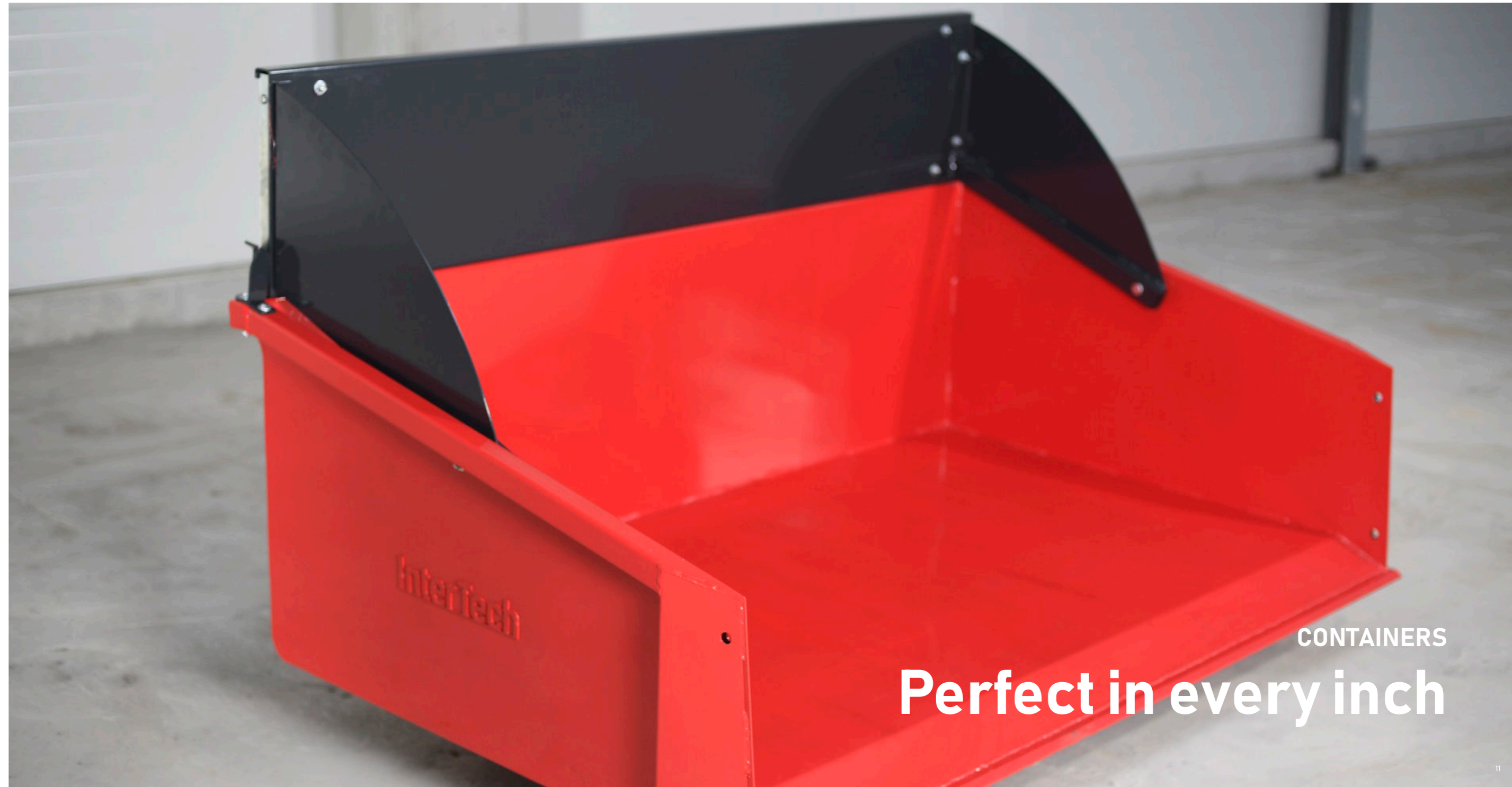

CONTAINERS

Perfect in every inch

CONTAINERS

High-loading containers are perfect for all kinds of work where there is a need to transport small loads. Thanks to the hydraulic tipping mechanism, it is easy to unload grain, sand, or other bulk materials. Specially designed locks ensure safety in use.

The containers can be mounted at the rear or front of the tractor on a three-point suspension system. Due to their design, they can also function as a counterbalance. They are adapted to work with a front loader or loaders.

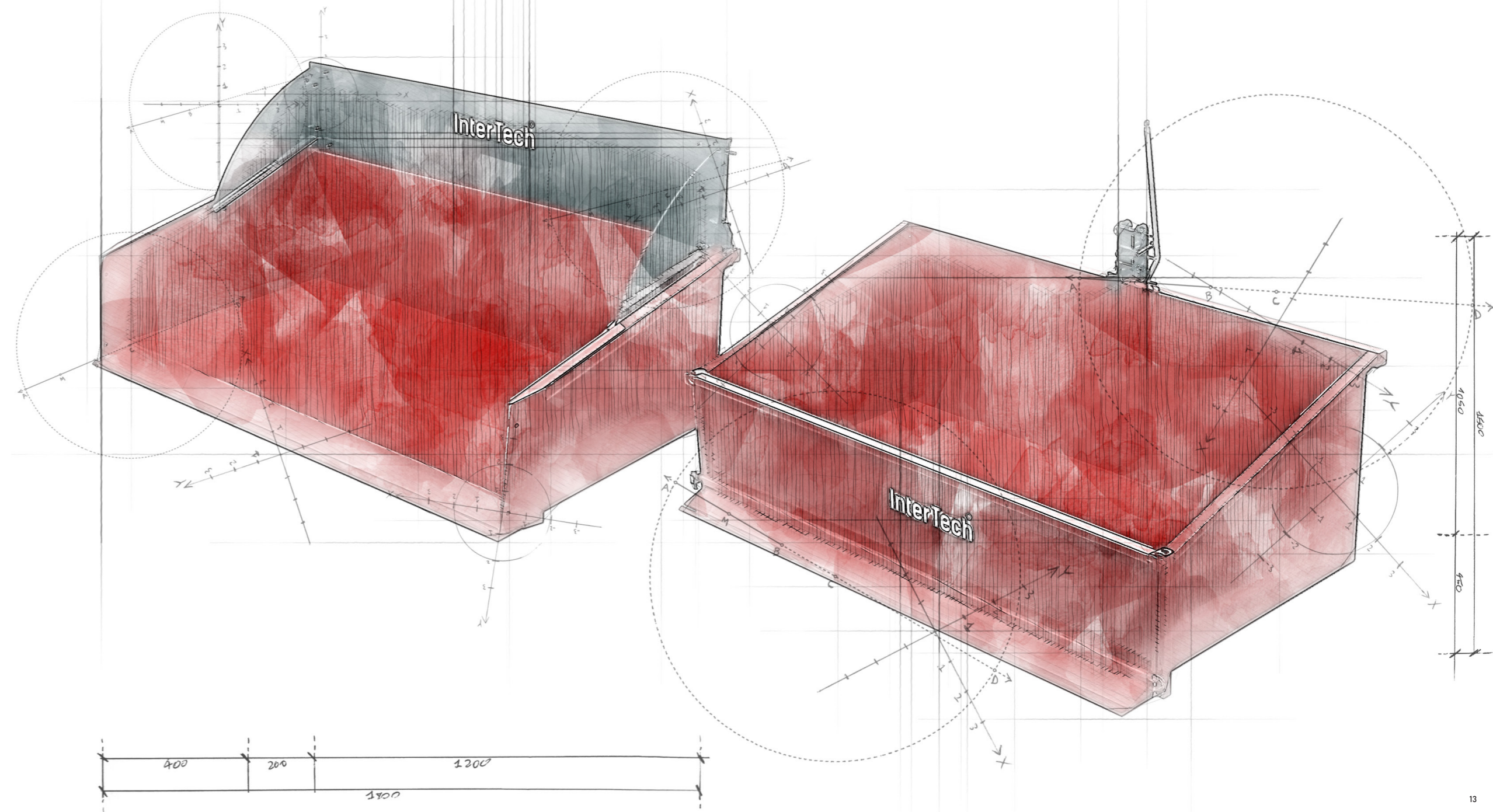



MECHANICAL REAR CONTAINER

Machine no	SS01	SS02	SS03	SS04	SS05
Width (m)	1,2	1,4	1,6	1,8	2,0
Capacity (m ³)	0,65	0,75	0,85	1,0	1,1
Weight (kg)	190	205	220	235	250
Equipment					
TUZ connection	✓	✓	✓	✓	✓
Service package (PLN)	● ●	● ●	● ●	● ●	● ●



LIGHT HYDRAULIC REAR CONTAINER

Machine no	SS06	SS07	SS08
Width (m)	1,6	1,8	2,0
Capacity (m ³)	0,95	1,05	1,15
Number of cylinders (pcs.)	1	1	2
Weight (kg)	345	360	375
Equipment			
TUZ connection	✓	✓	✓
EURO/TUZ connection (PLN)	●	●	●
Service package (PLN)	● ●	● ●	● ●

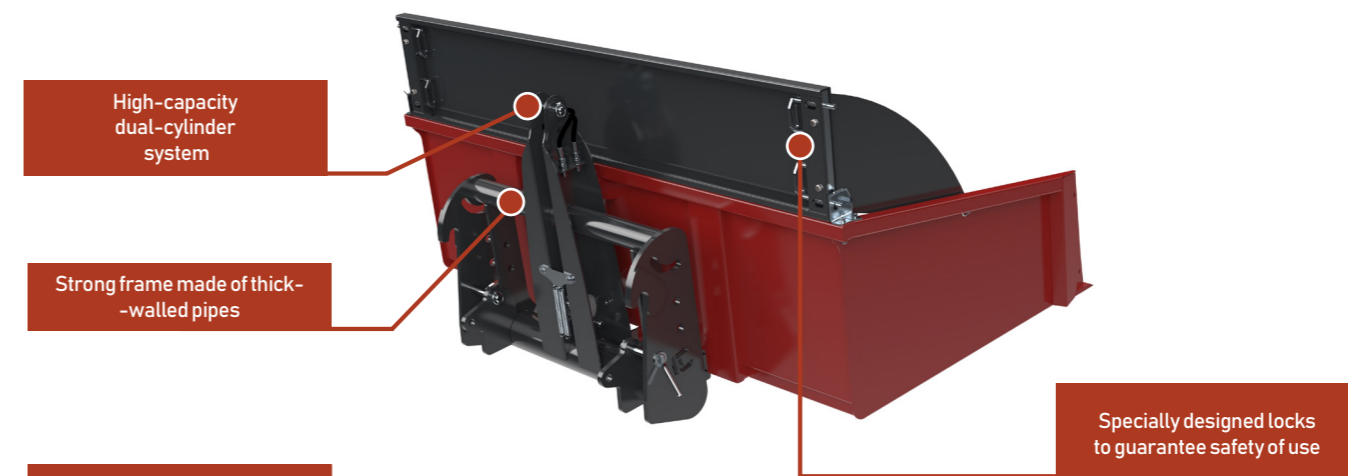

HYDRAULIC REAR CONTAINER

Machine no	SS09	SS10	SS11	SS12	SS13
Width (m)	1,6	1,8	2,0	2,2	2,4
Capacity (m ³)	1,00	1,15	1,25	1,35	1,50
Number of cylinders (pcs.)	2	2	2	2	2
Weight (kg)	480	500	520	540	560
Equipment					
EURO/TUZ connection (PLN)	✓	✓	✓	✓	✓
Service package (PLN)	● ●	● ●	● ●	● ●	● ●

SMART
line

- ✓ Standard equipment
- Optional equipment
- Option not available
- Recommended
- Especially recommended



BALE GRIPPER

Multifunctionality and precision



BALE GRIPPER

Bale grippers are used in the transport, sorting, loading, and unloading of wood, waste paper, bales of silage, hay, and straw. Thanks to the thoughtful design, the transfer of a single bale is non-invasive to the others. Bale grippers have appropriately curved arms ensuring the proper compression of the bales, as well as safe and long-lasting operation.

Grippers with tines, depending on the number of tines, can transfer even two bales at once, which shortens the work time in the field. Wood grippers are used for the safe and quick transport, loading, unloading, and sorting of wood. All grapples are compatible with front loaders or loaders.

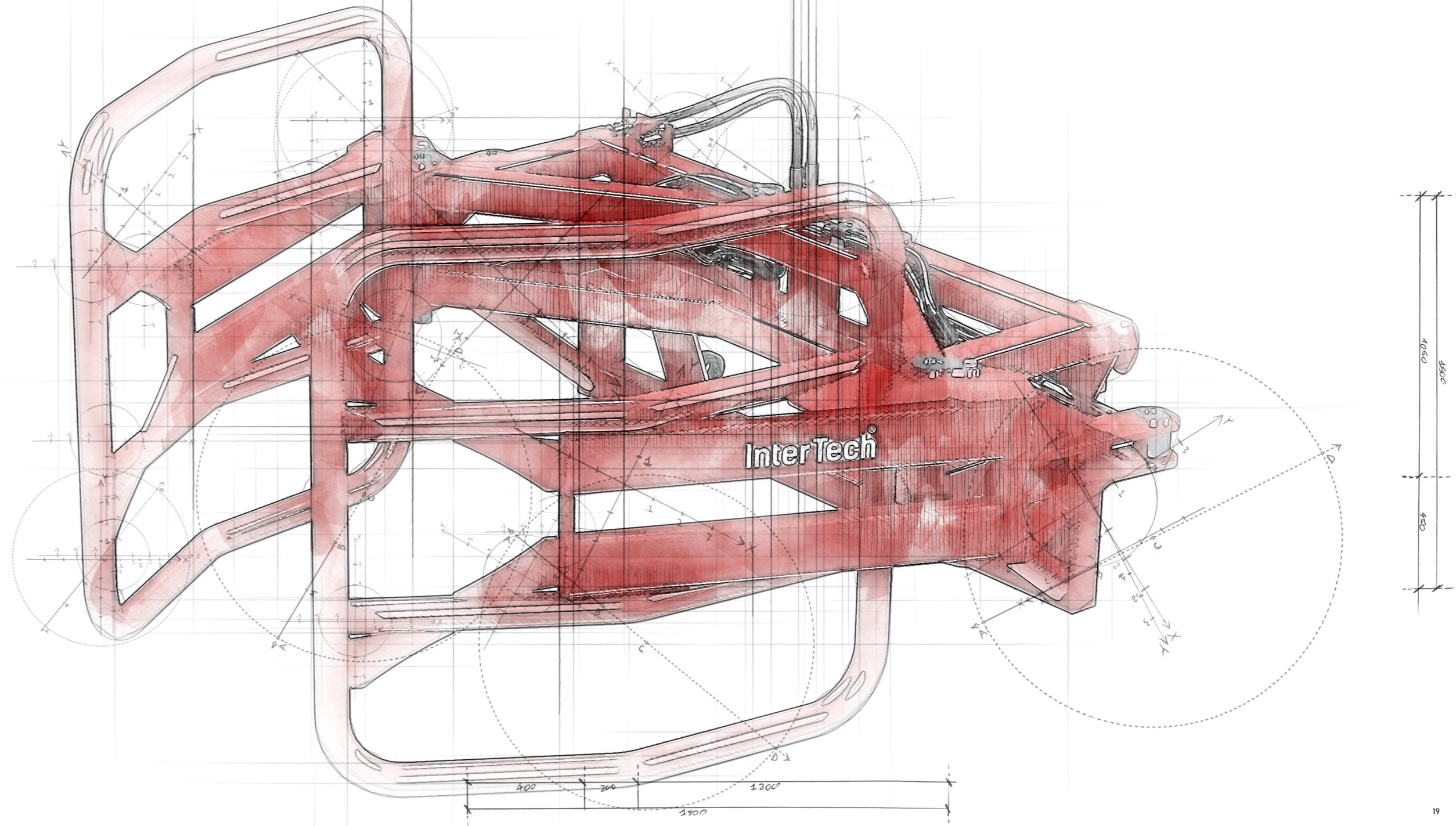

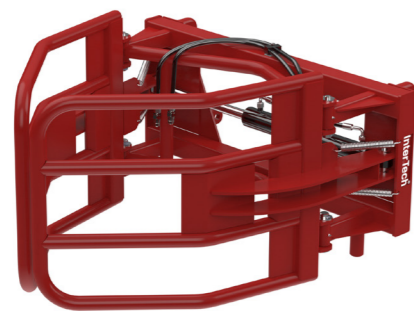

BALE GRIPPER 1.2/1

Machine no	SC01
Bale size (mm)	1200
Load capacity (kg)	700
Number of cylinders (pcs.)	1
Weight (kg)	201
Equipment	
EURO or SMS connection	✓
Telehandler mount	—
Skid steer mount (PLN)	●
Hydraulic lock supporting the 3rd section (PLN)	●
Service package (PLN)	●●



BALE GRIPPER 1.2/2

Machine no	SC02
Bale size (mm)	1200
Load capacity (kg)	700
Number of cylinders (pcs.)	2
Weight (kg)	173
Equipment	
EURO or SMS connection	✓
Telehandler mount	—
Skid steer mount (PLN)	●
Hydraulic lock supporting the 3rd section (PLN)	●
Service package (PLN)	●●

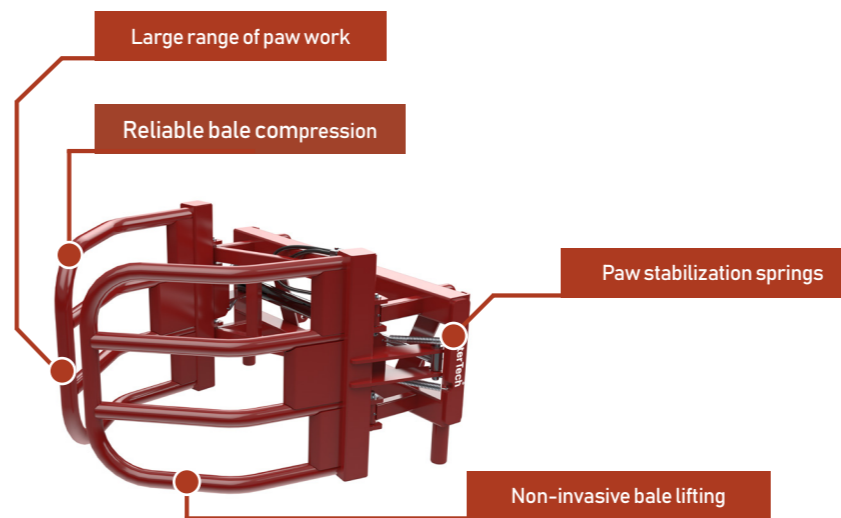

BALE GRIPPER LARGE

Machine no	SC03
Bale size (mm)	1200–1800
Load capacity (kg)	1000
Number of cylinders (pcs.)	1
Weight (kg)	256
Equipment	
EURO or SMS connection	✓
Telehandler mount	●
Skid steer mount (PLN)	●
Hydraulic lock supporting the 3rd section (PLN)	●
Service package (PLN)	●●

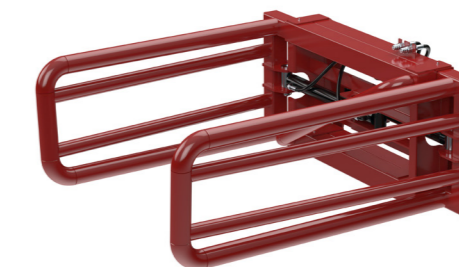

BALE GRIPPER RECTANGULAR IT 01

Machine no	SC04
Bale size (mm)	995–2000
Load capacity (kg)	700
Number of cylinders (pcs.)	2
Weight (kg)	250
Equipment	
EURO or SMS connection	✓
Telehandler mount	●
Skid steer mount (PLN)	●
Hydraulic lock supporting the 3rd section (PLN)	●
Service package (PLN)	●●

SMART
line

- ✓ Standard equipment
- Optional equipment
- Option not available
- Recommended
- Especially recommended



BALE GRIPPER WITH TINES

Machine no	SC05
Bale size (mm)	1200 – 1 bela
Number of tines (pcs.)	8
Load capacity (kg)	900
Number of cylinders (pcs.)	1
Weight (kg)	240
Equipment	
EURO or SMS connection	✓
Telehandler mount	●
Skid steer mount (PLN)	●
Hydraulic lock supporting the 3rd section (PLN)	●
Service package (PLN)	●●



BALE GRIPPER WITH TINES HD

Machine no	SC06
Bale size (mm)	1200 – 2 bele
Number of tines (pcs.)	8/2
Load capacity (kg)	1800
Number of cylinders (pcs.)	1
Weight (kg)	300
Equipment	
EURO or SMS connection	✓
Telehandler mount	●
Skid steer mount (PLN)	—
Hydraulic lock supporting the 3rd section (PLN)	●
Service package (PLN)	●●



WOOD GRIPPER

Machine no	SC07
Opening height (mm)	0–820
Load capacity (kg)	700
Number of cylinders (pcs.)	2
Weight (kg)	300
Equipment	
EURO or SMS connection	✓
Telehandler mount	●
Skid steer mount (PLN)	●
Hydraulic lock supporting the 3rd section (PLN)	●
Service package (PLN)	●●



WOOD ARM FOR PALLET FORK

Machine no	SC08
Opening height (mm)	0–820
Number of cylinders (pcs.)	1
Weight (kg)	50
Equipment	
2A cat. connection	✓
3A cat. connection (PLN)	●
Service package (PLN)	●●

SMART
line

- ✓ Standard equipment
- Optional equipment
- Option not available
- Recommended
- Especially recommended



LIFTS AND TRANSPORTERS

Stability and durability



LIFTS AND TRANSPORTERS



Lifts and transporters are used in loading, unloading, and transporting bales of silage, hay, straw, as well as various types of materials placed on carrying pallets and in big bag type sacks. Their application streamlines work by ensuring reliability. They are adapted for use with front loaders and loaders.

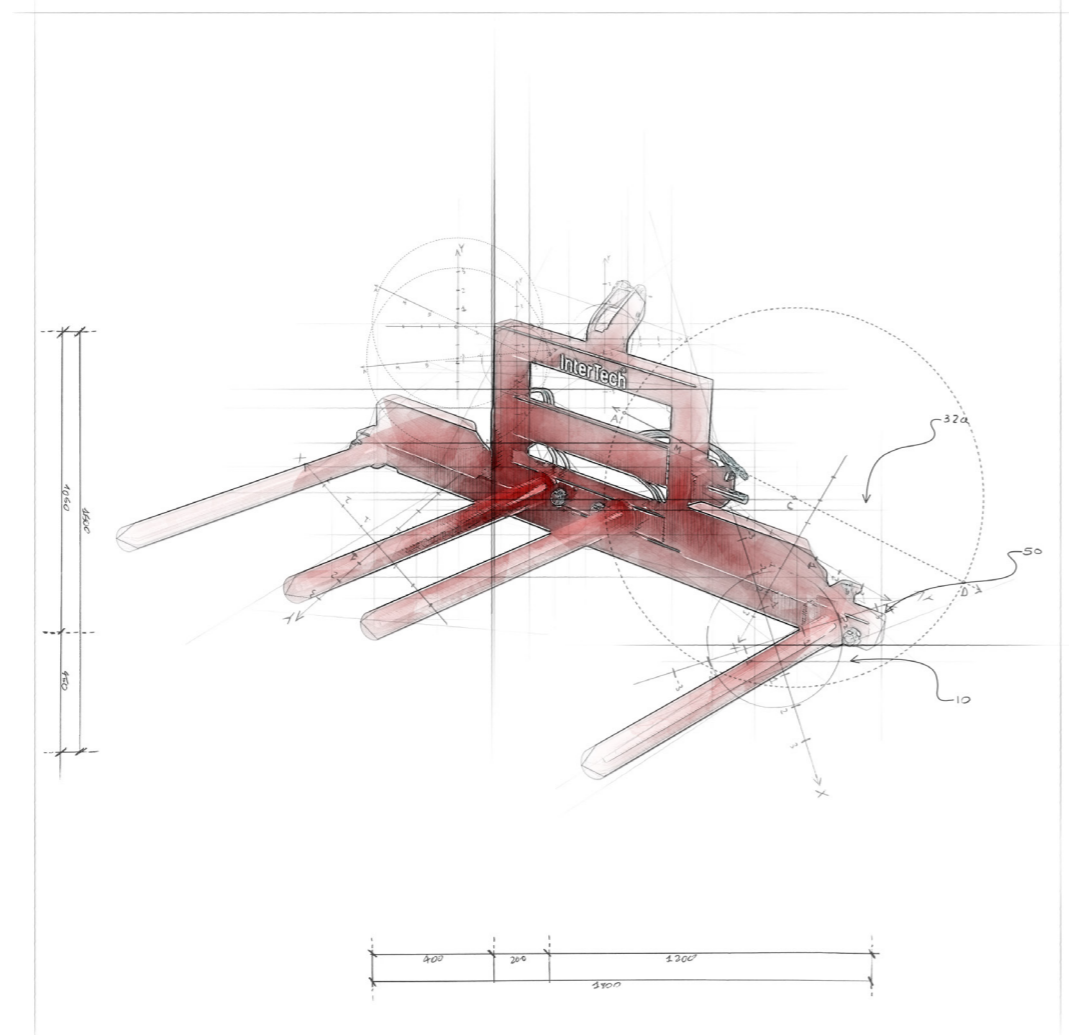

SMART
line



SINGLE HYDRAULIC BALE LIFT

Machine no	SPB01
Width (mm)	1200
Arm length (mm)	1250
Number of tines (pcs.)	2/2
Load capacity (kg)	700
Weight (kg)	185
Equipment	
EURO or SMS connection lub TUZ	✓
Telehandler mount	●
Skid steer mount (PLN)	●
Service package (PLN)	●●



DOUBLE HYDRAULIC BALE LIFT

Machine no	SPB02
Width (mm)	2400
Arm length (mm)	1250
Number of tines (pcs.)	4/4
Load capacity (kg)	1400
Weight (kg)	280
Equipment	
EURO or SMS connection lub TUZ	✓
Telehandler mount	●
Skid steer mount (PLN)	—
Service package (PLN)	●●

- ✓ Standard equipment
- Optional equipment
- Option not available
- Recommended
- Especially recommended



SINGLE MECHANICAL BALE LIFT

Machine no	SPB03
Width (mm)	1100
Arm length (mm)	1250
Number of tines (pcs.)	0/2
Load capacity (kg)	700
Weight (kg)	104
Equipment	
EURO or SMS connection lub TUZ	✓
Telehandler mount	●
Skid steer mount (PLN)	●
Service package (PLN)	●●

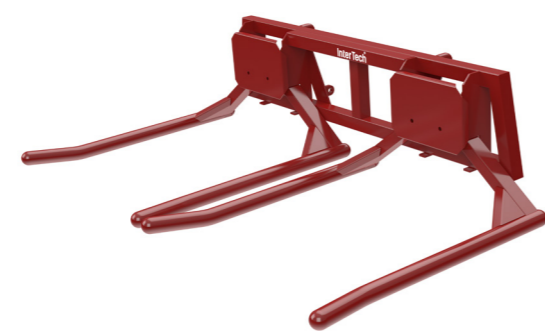

DOUBLE MECHANICAL BALE LIFT

Machine no	SPB04
Width (mm)	2100
Arm length (mm)	1250
Number of tines (pcs.)	0/4
Load capacity (kg)	1400
Weight (kg)	165
Equipment	
EURO or SMS connection lub TUZ	✓
Telehandler mount	●
Skid steer mount (PLN)	●
Service package (PLN)	●●



BALE TRANSPORTER

Machine no	ST01	ST02	ST03	ST04
Number of tines (pcs.)	2	3	4	6
Load capacity (kg)	700	700	1500	1500
Number of bales (pcs.)	1	1	2	2
Weight (kg)	40	40	55	55
Equipment				
EURO or SMS connection	✓	✓	✓	✓
Telehandler mount	-	-	●	●
Skid steer mount (PLN)	●	●	-	-
Service package (PLN)	●●	●●	●●	●●

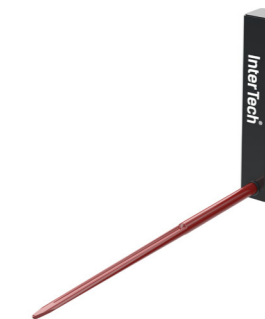

BALE TRANSPORTER FOR PALLET FORK

Machine no	ST05
Load capacity (kg)	350
Weight (kg)	11
Equipment	
Zine 1100 (mm)	✓
2A cat. connection	✓
3A cat. connection (PLN)	●
Service package (PLN)	●●

- ✓ Standard equipment
- Optional equipment
- Option not available
- Recommended
- Especially recommended

SMART
line



BUCKETS
Loading with class



BUCKETS

The buckets are designed for tasks related to the loading, unloading, and transport of bulk materials such as soil, stones, agricultural products, fertilizers, etc. They are characterized by stability and exceptional durability due to the use of suitable components and perfectly executed welds.

Depending on their size and purpose, they can be attached to front loaders, telescopic loaders, or mini loaders. They will perform well both on farms and construction sites.

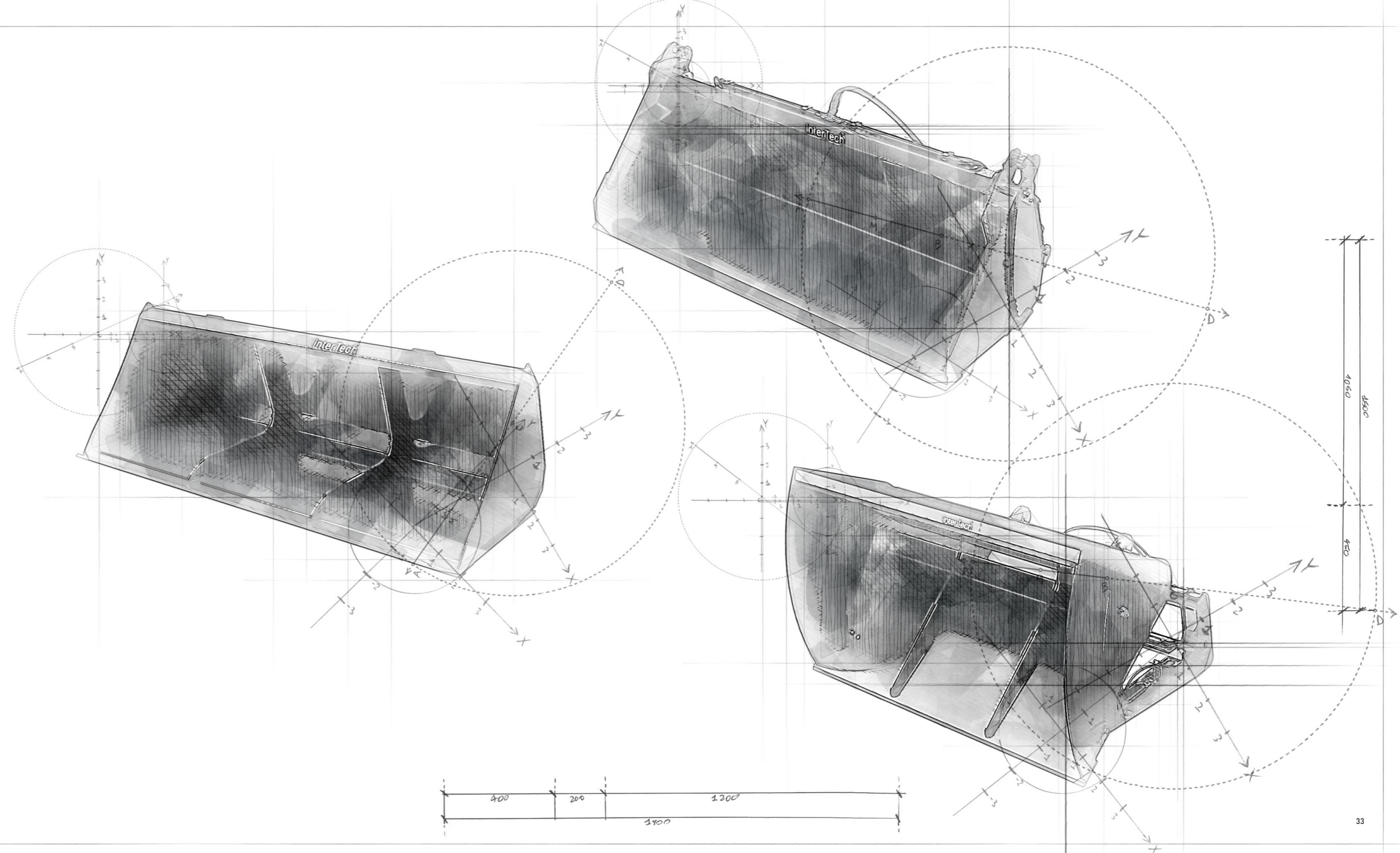

TRAPEZOIDAL BUCKET



Machine no	SL01	SL02	SL03	SL04	SL05
Width (m)	1,5	1,8	2,0	2,2	2,4
Capacity (m ³)	0,36	0,43	0,48	0,53	0,58
Weight (kg)	149	167	179	198	220
Equipment					
EURO or SMS connection	✓	✓	✓	✓	✓
Telehandler mount	—	—	—	—	—
Skid steer mount (PLN)	●	●	●	●	●
Service package (PLN)	●●	●●	●●	●●	●●

TRAPEZOIDAL BUCKET HD



Machine no	SL06	SL07	SL08	SL09	SL10
Width (m)	1,5	1,8	2,0	2,2	2,4
Capacity (m ³)	0,38	0,45	0,50	0,56	0,61
Weight (kg)	175	200	220	235	255
Equipment					
EURO or SMS connection	✓	✓	✓	✓	✓
Telehandler mount	●	●	●	●	●
Skid steer mount (PLN)	●	●	●	●	●
Service package (PLN)	●●	●●	●●	●●	●●



VOLUMETRIC BUCKET

Machine no	SL11	SL12	SL13	SL14
Width (m)	1,8	2,0	2,2	2,4
Capacity (m ³)	0,70	0,78	0,86	0,94
Weight (kg)	269	295	321	358
Equipment				
EURO or SMS connection	✓	✓	✓	✓
Telehandler mount	—	—	●	●
Skid steer mount (PLN)	●	●	—	—
Service package (PLN)	●●	●●	●●	●●

- ✓ Standard equipment
- Optional equipment
- Option not available
- Recommended
- Especially recommended

DVD BUCKET



Machine no	SL15	SL16	SL17	SL18	SL19
Width (m)	1,6	1,8	2,0	2,2	2,4
Capacity (m ³)	0,62	0,70	0,78	0,85	0,93
Weight (kg)	210	230	260	280	305
Equipment					
EURO or SMS connection	✓	✓	✓	✓	✓
Telehandler mount	●	●	●	●	●
Skid steer mount (PLN)	●	●	—	—	—
Service package (PLN)	●●	●●	●●	●●	●●

TELEHANDLER VOLUMETRIC BUCKET



Machine no	SL20	SL21	SL22
Width (m)	2,0	2,2	2,4
Capacity (m ³)	1,45	1,60	1,75
Weight (kg)	550	580	600
Equipment			
EURO or SMS connection	—	—	—
Telehandler mount (PLN)	✓	✓	✓
Skid steer mount (PLN)	—	—	—
Service package (PLN)	●●	●●	●●



TELEHANDLER VOLUMETRIC BUCKET XXL

Machine no	SL23	SL24	SL25
Width (m)	2,0	2,2	2,4
Capacity (m ³)	2,0	2,20	2,40
Weight (kg)	845	890	935
Equipment			
EURO or SMS connection	—	—	—
Telehandler mount	✓	✓	✓
Skid steer mount (PLN)	—	—	—
Service package (PLN)	●●	●●	●●

- ✓ Standard equipment
- Optional equipment
- Option not available
- Recommended
- Especially recommended



AV BUCKET FOR LIGHT MATERIALS

Machine no	SL26	SL27	SL28	SL29
Width (m)	1,05	1,2	1,3	1,6
Capacity (m ³)	0,33	0,40	0,42	0,51
Weight (kg)	110	130	140	170
Equipment				
EURO or SMS connection	-	-	-	-
Telehandler mount	-	-	-	-
Skid steer mount (PLN)	✓	✓	✓	✓
Service package (PLN)	●●	●●	●●	●●



UNIVERSAL BUCKET MINI

Machine no	SL30	SL31	SL32	SL33	SL34
Width (m)	0,9	1,0	1,2	1,3	1,4
Capacity (m ³)	0,35	0,40	0,50	0,54	0,59
Weight (kg)	143	150	161	173	181
Equipment					
EURO or SMS connection	-	-	-	-	-
Telehandler mount	-	-	-	-	-
Skid steer mount (PLN)	✓	✓	✓	✓	✓
Service package (PLN)	●●	●●	●●	●●	●●



AV 4IN1 BUCKET

Machine no	SL35	SL36	SL37	SL38	SL39
Width (m)	1,1	1,2	1,3	1,4	1,6
Capacity (m ³)	0,15	0,17	0,18	0,20	0,24
Opening height (mm)	160	160	160	160	160
Weight (kg)	180	190	200	210	225
Equipment					
AVANT mount	✓	✓	✓	✓	✓
EURO or SMS connection	-	-	-	-	-
Telehandler mount	-	-	-	-	-
Skid steer mount (PLN)	✓	✓	✓	✓	✓
Service package (PLN)	●●	●●	●●	●●	●●

- ✓ Standard equipment
- Optional equipment
- Option not available
- Recommended
- Especially recommended



CONSTRUCTION 4IN1 BUCKET

Machine no	SL40	SL41	SL42	SL43	SL44
Width (m)	1,6	1,8	2,0	2,2	2,4
Capacity (m ³)	0,42	0,47	0,53	0,59	0,64
Opening height (mm)	650	650	650	650	650
Weight (kg)	355	405	450	500	540
Equipment					
EURO or SMS connection	✓	✓	✓	✓	✓
Telehandler mount	—	●	●	●	●
Skid steer mount (PLN)	●	—	—	—	—
Hydraulic lock supporting the 3rd section (PLN)	●	●	●	●	●
Service package (PLN)	●●	●●	●●	●●	●●



HIGH LOADING BUCKET

Machine no	SL45	SL46	SL47	SL48
Width (m)	1,6	1,8	2,0	2,2
Capacity (m ³)	0,60	0,70	0,80	0,90
Weight (kg)	430	470	520	547
Equipment				
EURO or SMS connection	✓	✓	✓	✓
Telehandler mount	●	●	●	●
Skid steer mount (PLN)	●	—	—	—
Hydraulic lock supporting the 3rd section (PLN)	●	●	●	●
Service package (PLN)	●●	●●	●●	●●



HIGH LOADING BUCKET XXL

Machine no	SL49	SL50
Width (m)	2,8	3,0
Capacity (m ³)	3,15	3,40
Weight (kg)	1460	1550
Equipment		
EURO or SMS connection	—	—
Telehandler mount	✓	✓
Skid steer mount (PLN)	—	—
Hydraulic lock supporting the 3rd section (PLN)	●	●
Service package (PLN)	●●	●●

- ✓ Standard equipment
- Optional equipment
- Option not available
- Recommended
- Especially recommended



SILAGE CUTTERS

Reach for more

SILAGE CUTTERS

Silage cutters are used for extracting silage directly from the stack. The proper design ensures that its structure is not compromised during the process, which allows the fermentation to proceed correctly, and the cut surface remains smooth.

Moreover, the even material intake with optimal pressure is ensured by the cooperation of two cylinders with a lock that supports the third section.

The range also includes a bale cutter used to cut bales of silage or straw. Its solidly made teeth guarantee a long service life while reducing the risk of damage.

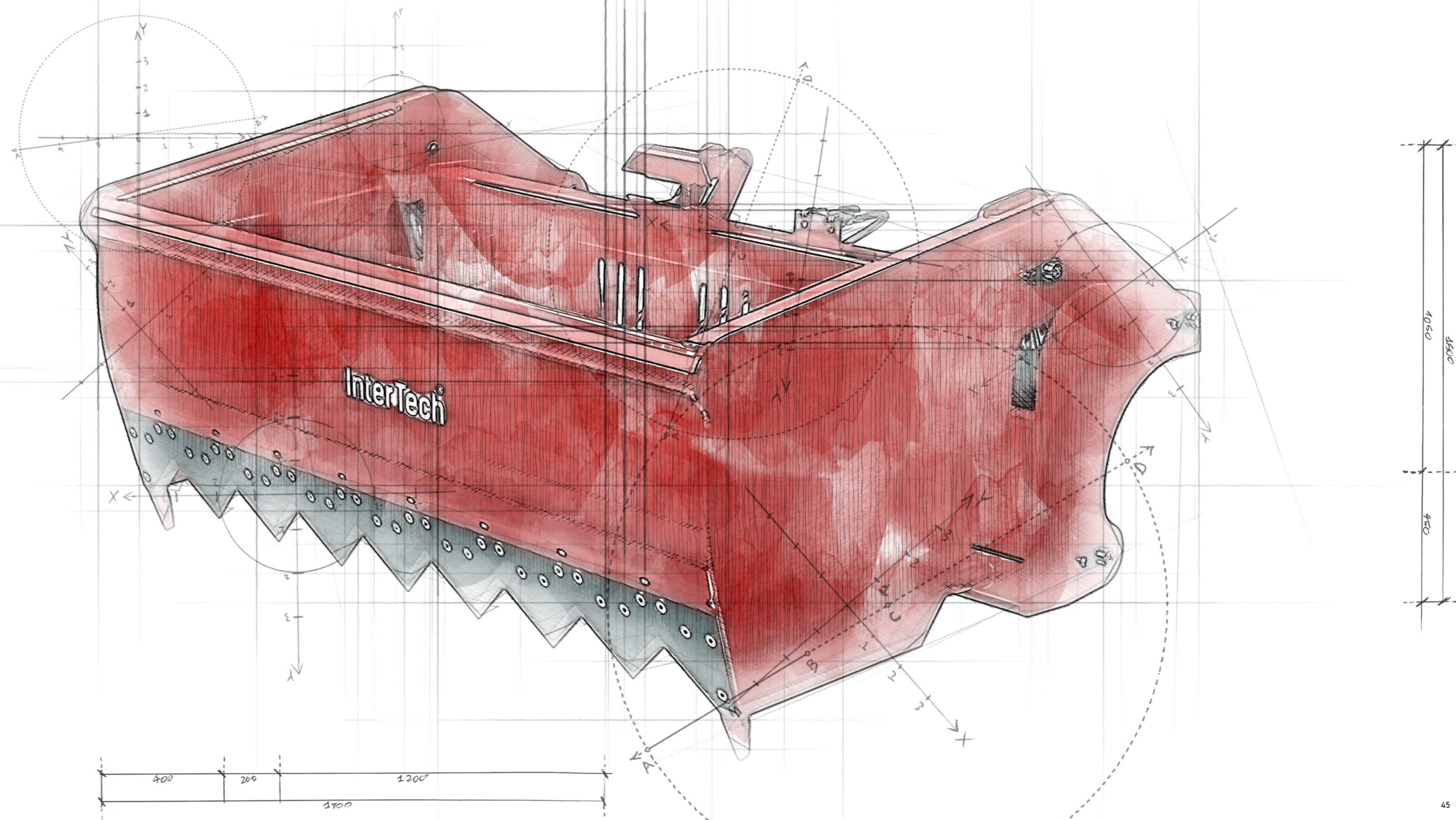



SILLAGE CUTTER „ALIGATOR”

Machine no	SW01	SW02
Width (m)	1,4	1,6
Capacity (m ³)	0,95	1,10
Opening height (mm)	940	940
Number of cylinders (pcs.)	2	2
Weight (kg)	630	700

Equipment		
EURO or SMS connection	✓	✓
Telehandler mount (PLN)	—	●
Skid steer mount (PLN)	—	—
Hydraulic lock supporting the 3rd section (PLN)	●	●
Service package (PLN)	●●	●●

SILLAGE CUTTER

Machine no	SW03
Width (m)	1,6
Capacity (m ³)	1,05
Opening height (mm)	1340
Number of cylinders (pcs.)	2
Weight (kg)	648

Equipment	
EURO or SMS connection	✓
Telehandler mount (PLN)	●
Skid steer mount (PLN)	—
Hydraulic lock supporting the 3rd section (PLN)	●
Service package (PLN)	●●



SMART

line

BALE CUTTER

Machine no	SW04
Width (m)	1,6
Capacity (m ³)	0,5
Opening height (mm)	1300
Number of cylinders (pcs.)	2
Weight (kg)	540

Equipment	
EURO or SMS connection	✓
Telehandler mount (PLN)	●
Skid steer mount (PLN)	●
Hydraulic lock supporting the 3rd section (PLN)	●
Service package (PLN)	●●

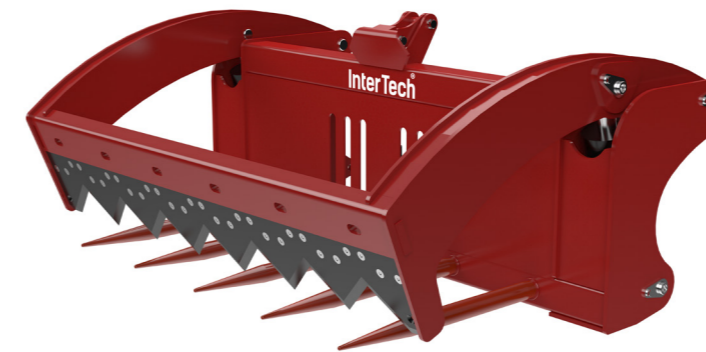

- ✓ Standard equipment
- Optional equipment
- Option not available
- Recommended
- Especially recommended



GRAB BUCKET

Efficiency without loss

GRAB BUCKET

Grab buckets are designed for the transport of manure, corn, and other materials with small fractions that need support from below over the entire surface.

The spillage of transported material is minimized thanks to the screwed-on sides, and their appropriate design guarantees safety and comfort of work. The conical shape of the grab buckets allows for filling and emptying without loss. The right pressing force is provided by properly selected hydraulic cylinders.

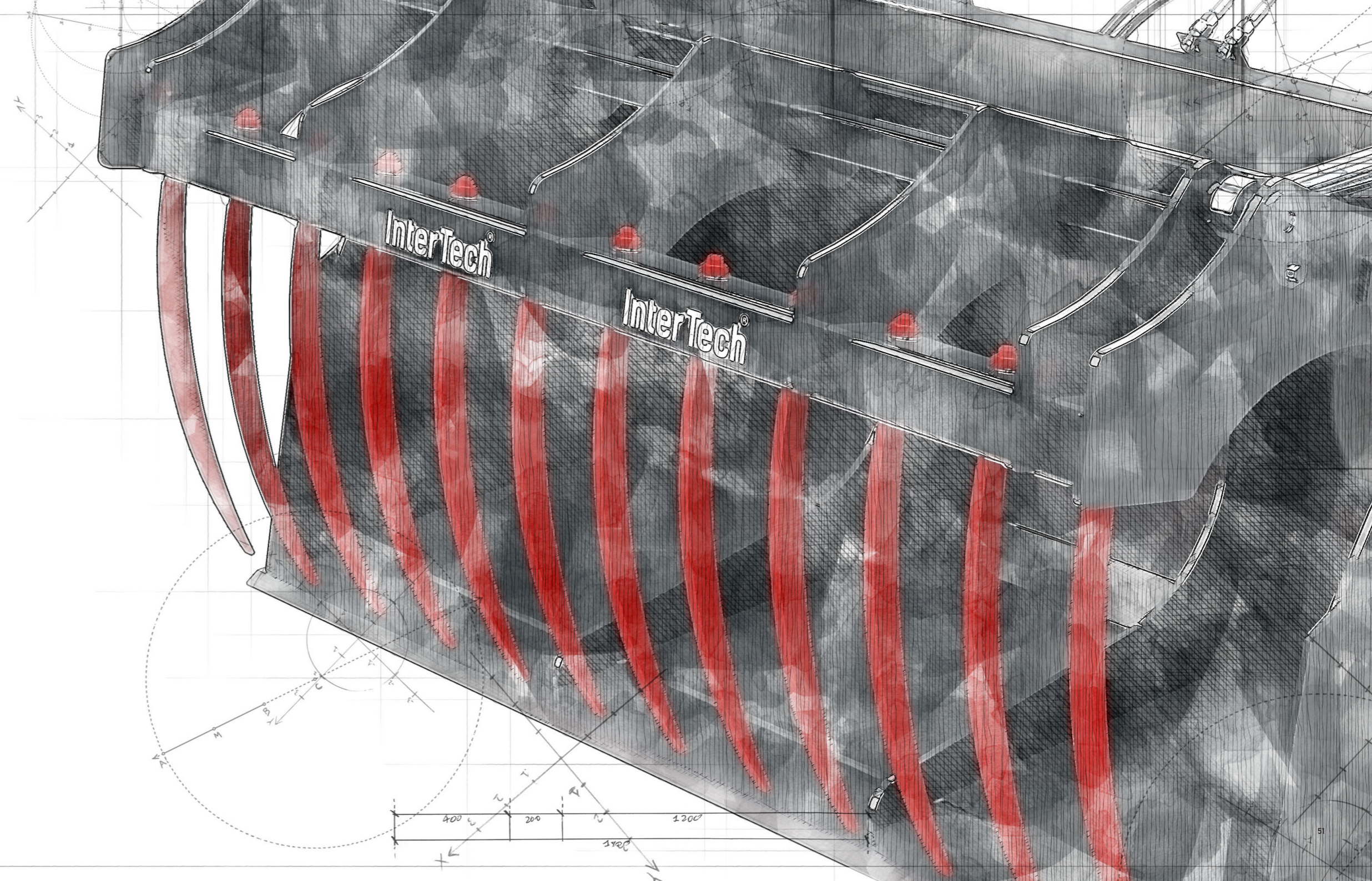



GRAB BUCKET FORGED TINE

Machine no	SLK01	SLK02	SLK03	SLK04	SLK05
Width (m)	1,5	1,8	2,0	2,2	2,4
Capacity (m ³)	0,75	0,90	1,0	1,1	1,2
Opening height (mm)	1000	1000	1000	1000	1000
Number of cylinders (pcs.)	2	2	2	2	2
Weight (kg)	285	381	406	430	460
Equipment					
EURO or SMS connection	✓	✓	✓	✓	✓
Telehandler mount (PLN)	—	—	●	●	●
Skid steer mount (PLN)	●	●	—	—	—
Service package (PLN)	●●	●●	●●	●●	●●



GRAB BUCKET AV

Machine no	SLK11	SLK12	SLK13
Width (m)	1,2	1,3	1,4
Capacity (m ³)	0,30	0,33	0,36
Opening height (mm)	810	810	810
Number of cylinders (pcs.)	1	1	1
Weight (kg)	160	175	185
Equipment			
AVANT mount	✓	✓	✓
EURO or SMS connection	—	—	—
Telehandler mount (PLN)	—	—	—
Skid steer mount (PLN)	✓	✓	✓
Service package (PLN)	●●	●●	●●

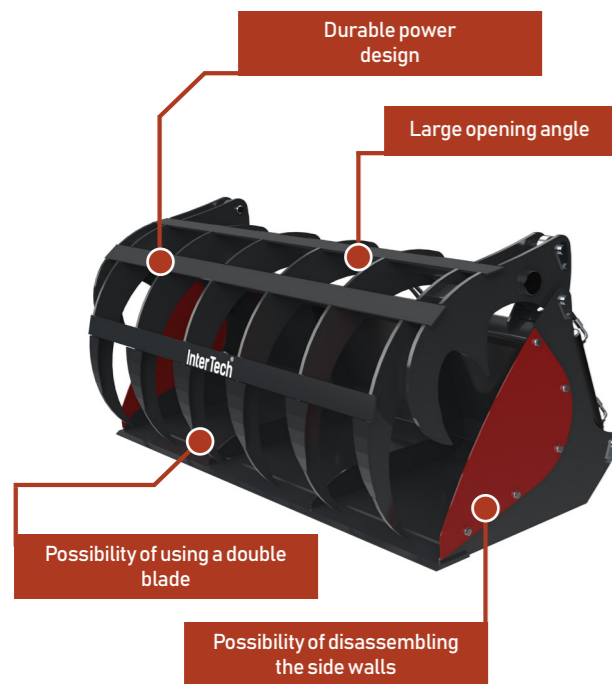

GRAB BUCKET BURNED TINE

Machine no	SLK06	SLK07	SLK08	SLK09	SLK10
Width (m)	1,5	1,8	2,0	2,2	2,4
Capacity (m ³)	0,66	0,78	0,88	0,97	1,06
Opening height (mm)	1500	1500	1500	1500	1500
Number of cylinders (pcs.)	2	2	2	2	2
Weight (kg)	391	504	550	571	593
Equipment					
EURO or SMS connection	✓	✓	✓	✓	✓
Telehandler mount (PLN)	●	●	●	●	●
Skid steer mount (PLN)	●	●	—	—	—
Service package (PLN)	●●	●●	●●	●●	●●

- ✓ Standard equipment
- Optional equipment
- Option not available
- Recommended
- Especially recommended



GRAB BUCKET TELEHANDLERS

Machine no	SLK14	SLK15	SLK16
Width (m)	2.0	2.2	2.4
Capacity (m ³)	1.48	1.63	1.78
Opening height (mm)	1530	1530	1530
Number of cylinders (pcs.)	2	2	2
Weight (kg)	810	830	845
Equipment			
EURO or SMS connection	—	—	—
Telehandler mount (PLN)	✓	✓	✓
Skid steer mount (PLN)	—	—	—
Hydraulic lock supporting the 3rd section (PLN)	●	●	●
Service package (PLN)	●●	●●	●●

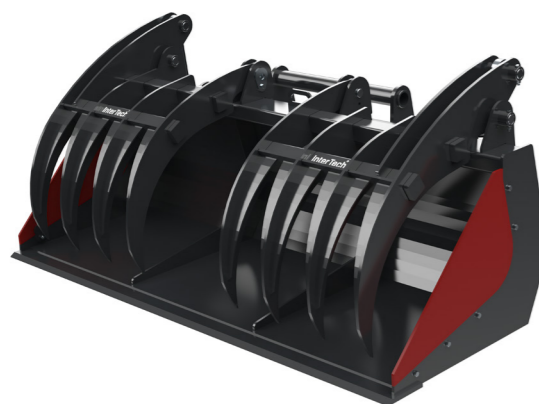

GRAB BUCKET MULTI-GRAB

Machine no	SLK17	SLK18	SLK19
Width (m)	2.0	2.2	2.4
Capacity (m ³)	1.05	1.15	1.26
Opening height (mm)	1650	1650	1650
Number of cylinders (pcs.)	2	2	2
Weight (kg)	710	750	790
Equipment			
EURO or SMS connection	—	—	—
Telehandler mount (PLN)	✓	✓	✓
Skid steer mount (PLN)	—	—	—
Hydraulic lock supporting the 3rd section (PLN)	●	●	●
Service package (PLN)	●●	●●	●●



GRAB BUCKET MULTI

Machine no	SLK20	SLK21	SLK22
Width (m)	2.0	2.2	2.4
Capacity (m ³)	0.88	0.92	1.01
Opening height (mm)	1380	1380	1380
Number of cylinders (pcs.)	2	2	2
Weight (kg)	680	710	740
Equipment			
EURO or SMS connection	—	—	—
Telehandler mount (PLN)	✓	✓	✓
Skid steer mount (PLN)	—	—	—
Hydraulic lock supporting the 3rd section (PLN)	●	●	●
Service package (PLN)	●●	●●	●●

- ✓ Standard equipment
- Optional equipment
- Option not available
- Recommended
- Especially recommended



GRAB AND FORKS
**Power and
strength combined**

GRAB AND FORKS

Forks and grabs are dedicated to transporting manure, silage, or corn, among other materials.

Depending on the model, the angle of opening of the movable frame varies, as well as the possibility of aggregation with loaders and stackers. The rear wall prevents material from falling out during transport.

The proper selection of cylinders guarantees a secure grip of the jaws, while the sturdy frame ensures stability and confidence during transport.

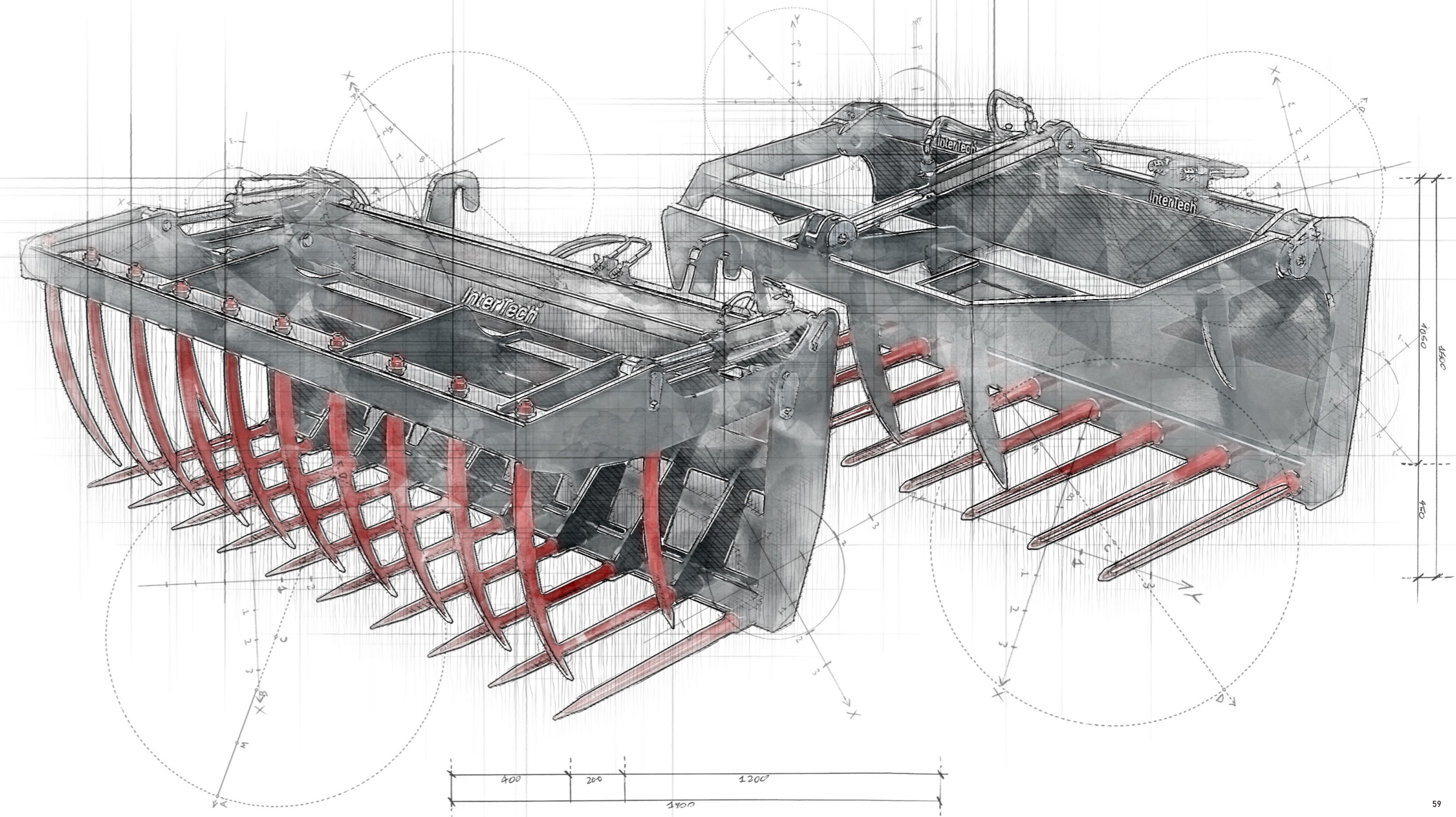



GRAB IT2

Machine no	SWK01	SWK02	SWK03	SWK04	SWK05	SWK06	SWK07
Width (m)	1,2	1,3	1,5	1,8	2,0	2,2	2,4
Capacity (m³)	0,82	0,87	1	1,13	1,26	1,38	1,51
Opening height (mm)	1210	1210	1210	1210	1210	1210	1210
Load capacity (kg)	500	600	700	800	900	1000	1100
Number of cylinders (pcs.)	2	2	2	2	2	2	2
Weight (kg)	170	200	235	285	325	365	405
Equipment							
EURO or SMS connection	✓	✓	✓	✓	✓	✓	✓
Telehandler mount (PLN)	—	—	●	●	●	●	●
Skid steer mount (PLN)	●	●	●	●	—	—	—
Service package (PLN)	●●	●●	●●	●●	●●	●●	●●



GRAB IT2 HD

Machine no	SWK08	SWK09	SWK10	SWK11	SWK12
Width (m)	1,5	1,8	2,0	2,2	2,4
Capacity (m³)	1	1,14	1,27	1,4	1,53
Opening height (mm)	1170	1170	1170	1170	1170
Load capacity (kg)	700	800	900	1000	1100
Number of cylinders (pcs.)	2	2	2	2	2
Weight (kg)	260	290	340	370	400
Equipment					
EURO or SMS connection	✓	✓	✓	✓	✓
Telehandler mount (PLN)	●	●	●	●	●
Skid steer mount (PLN)	●	●	—	—	—
Service package (PLN)	●●	●●	●●	●●	●●



MANURE FORK IT1

Machine no	SWK13	SWK14	SWK15	SWK16
Width (m)	1,2	1,5	1,8	2,0
Load capacity (kg)	600	700	800	900
Weight (kg)	125	143	158	173
Equipment				
EURO or SMS connection	✓	✓	✓	✓
Telehandler mount (PLN)	—	—	●	●
Skid steer mount (PLN)	●	●	●	●
Service package (PLN)	●●	●●	●●	●●

- ✓ Standard equipment
- Optional equipment
- Option not available
- Recommended
- Especially recommended

MANURE FORK IT1

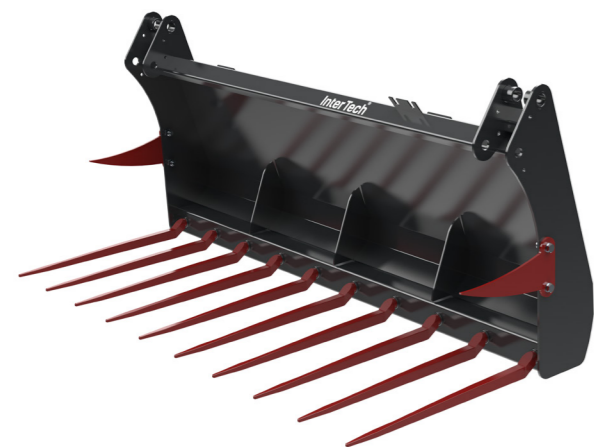

Machine no	SWK17	SWK18	SWK19	SWK20
Width (m)	1,2	1,5	1,8	2,0
Load capacity (kg)	600	700	800	900
Weight (kg)	137	152	167	182
Equipment				
EURO or SMS connection	✓	✓	✓	✓
Telehandler mount (PLN)	—	—	●	●
Skid steer mount (PLN)	●	●	●	●
Service package (PLN)	●●	●●	●●	●●

TELEHANDLERS GRAB HD

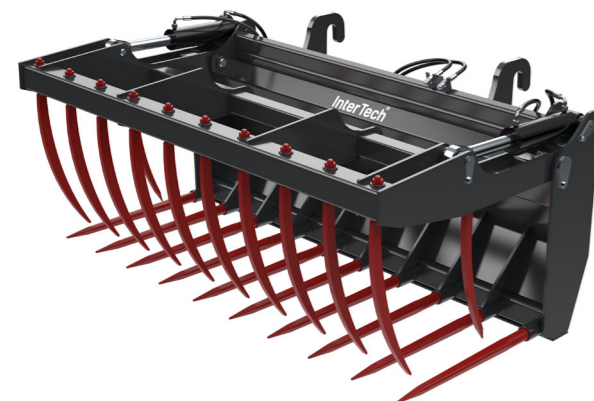

Machine no	SWK21	SWK22	SWK23
Width (m)	2,0	2,2	2,4
Capacity (m ³)	1,2	1,4	1,6
Opening height (mm)	1160	1160	1160
Number of cylinders (pcs.)	2	2	2
Weight (kg)	605	640	670
Equipment			
EURO or SMS connection	—	—	—
Telehandler mount (PLN)	✓	✓	✓
Skid steer mount (PLN)	—	—	—
Hydraulic lock supporting the 3rd section (PLN)	●	●	●
Service package (PLN)	●●	●●	●●

AV MINI GRAB



Machine no	SWK24	SWK25	SWK26	SWK27
Width (m)	1,1	1,2	1,3	1,4
Capacity (m ³)	0,24	0,26	0,28	0,30
Opening height (mm)	840	840	840	840
Number of cylinders (pcs.)	1	1	1	1
Weight (kg)	150	160	175	185
Equipment				
EURO or SMS connection	—	—	—	—
Telehandler mount (PLN)	—	—	—	—
Skid steer mount (PLN)	✓	✓	✓	✓
Service package (PLN)	●●	●●	●●	●●

- ✓ Standard equipment
- Optional equipment
- Option not available
- Recommended
- Especially recommended



GRAB MINI 01

Machine no	SWK28	SWK29	SWK30	SWK31
Width (m)	0,9	1,0	1,2	1,4
Capacity (m ³)	0,30	0,35	0,42	0,50
Opening height (mm)	1070	1070	1070	1070
Number of cylinders (pcs.)	1	1	1	1
Weight (kg)	165	175	190	205
Equipment				
EURO or SMS connection	—	—	—	—
Telehandler mount (PLN)	—	—	—	—
Skid steer mount (PLN)	✓	✓	✓	✓
Service package (PLN)	● ●	● ●	● ●	● ●



GRAB MINI 02

Machine no	SWK32	SWK33	SWK34
Width (m)	1,1	1,3	1,5
Capacity (m ³)	0,35	0,40	0,45
Opening height (mm)	840	840	840
Number of cylinders (pcs.)	2	2	2
Weight (kg)	190	215	230
Equipment			
EURO or SMS connection	—	—	—
Telehandler mount (PLN)	—	—	—
Skid steer mount (PLN)	✓	✓	✓
Service package (PLN)	● ●	● ●	● ●

- ✓ Standard equipment
- Optional equipment
- Option not available
- Recommended
- Especially recommended

PALLET FORKS

Pallet forks are dedicated to the transport of materials stored on pallets. The ability to adjust the fork width means that they can be used for a much wider range of applications. The solid construction and precision manufacturing ensure that this product is highly durable.

The big bag lift eases the transport of materials commonly used in agriculture, such as feed, as well as semi-finished products in manufacturing plants.

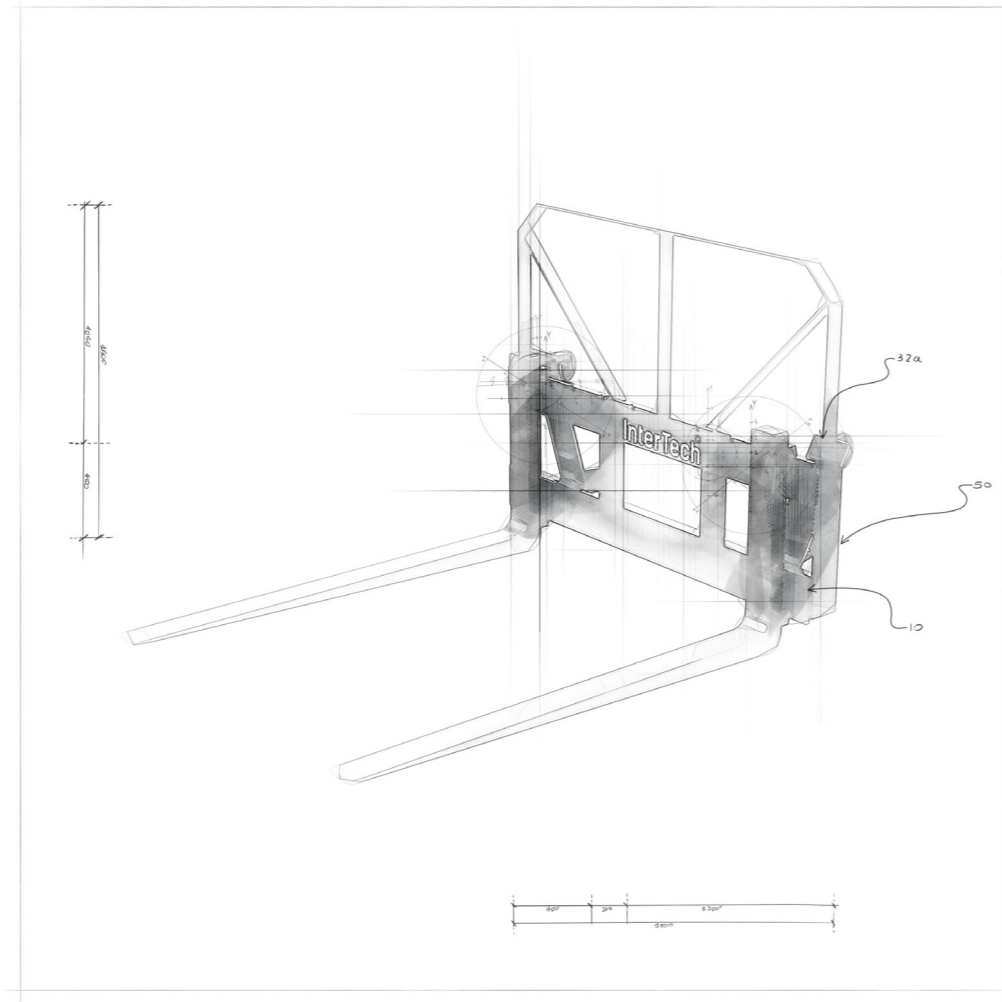

PALLET FORK IT

Machine no	SP01	SP02
Model	2A	3A
Fork dimensions (mm)	80/40/1200	100/45/1200
Load capacity (kg)	2000	3000
Weight (kg)	120	140
Equipment		
EURO or SMS connection	✓	—
Telehandler mount (PLN)	—	✓
Skid steer mount (PLN)	●	—
Sleeves for tines (PLN)	●	●
Service package (PLN)	●●	●●



PALLET FORK IT WITH TOP EXTENSION

Machine no	SP03	SP04
Model	2A	3A
Fork dimensions (mm)	80/40/1200	100/45/1200
Load capacity (kg)	2000	3000
Weight (kg)	125	145
Equipment		
EURO or SMS connection	✓	—
Telehandler mount (PLN)	—	✓
Skid steer mount (PLN)	●	—
Sleeves for tines (PLN)	●	●
Service package (PLN)	●●	●●

SMART line



BIG BAG LIFT

Machine no	SI03
Load capacity (kg)	1100
Weight (kg)	105
Equipment	
EURO or SMS connection	✓
Telehandler mount (PLN)	—
Skid steer mount (PLN)	●
Service package (PLN)	●●

- ✓ Standard equipment
- Optional equipment
- Option not available
- Recommended
- Especially recommended



REDUCTION

Compatibility is fundamental

REDUCTION

Reductions allow for operation without the need for a front loader. They act as a connector, thanks to which equipment with different mountings can be aggregated effortlessly.

Their remarkable advantage is the availability and compatibility with practically every mounting on the market.

Additionally, thanks to the reducers, users who only have a three-point suspension system can use machines dedicated to front loaders.

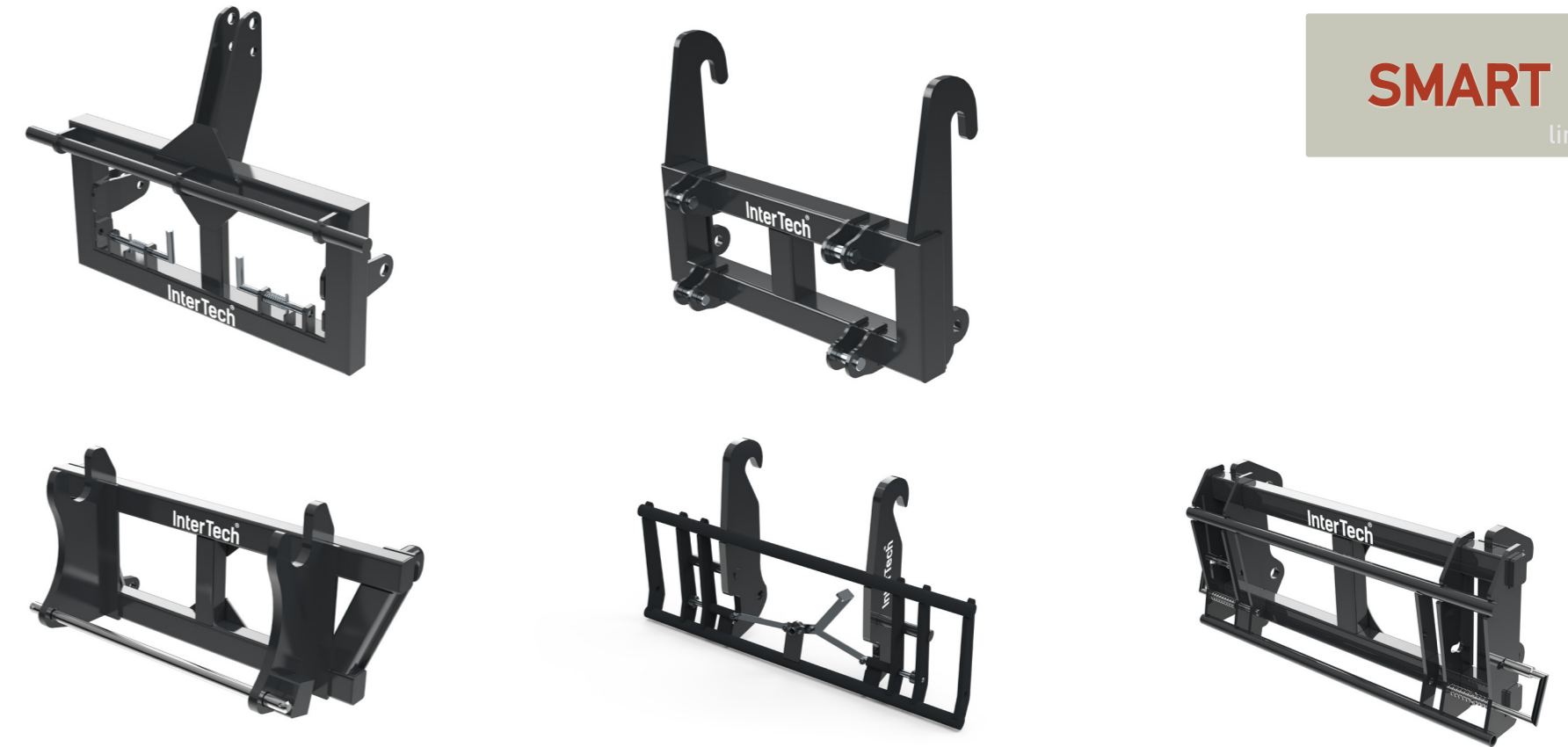
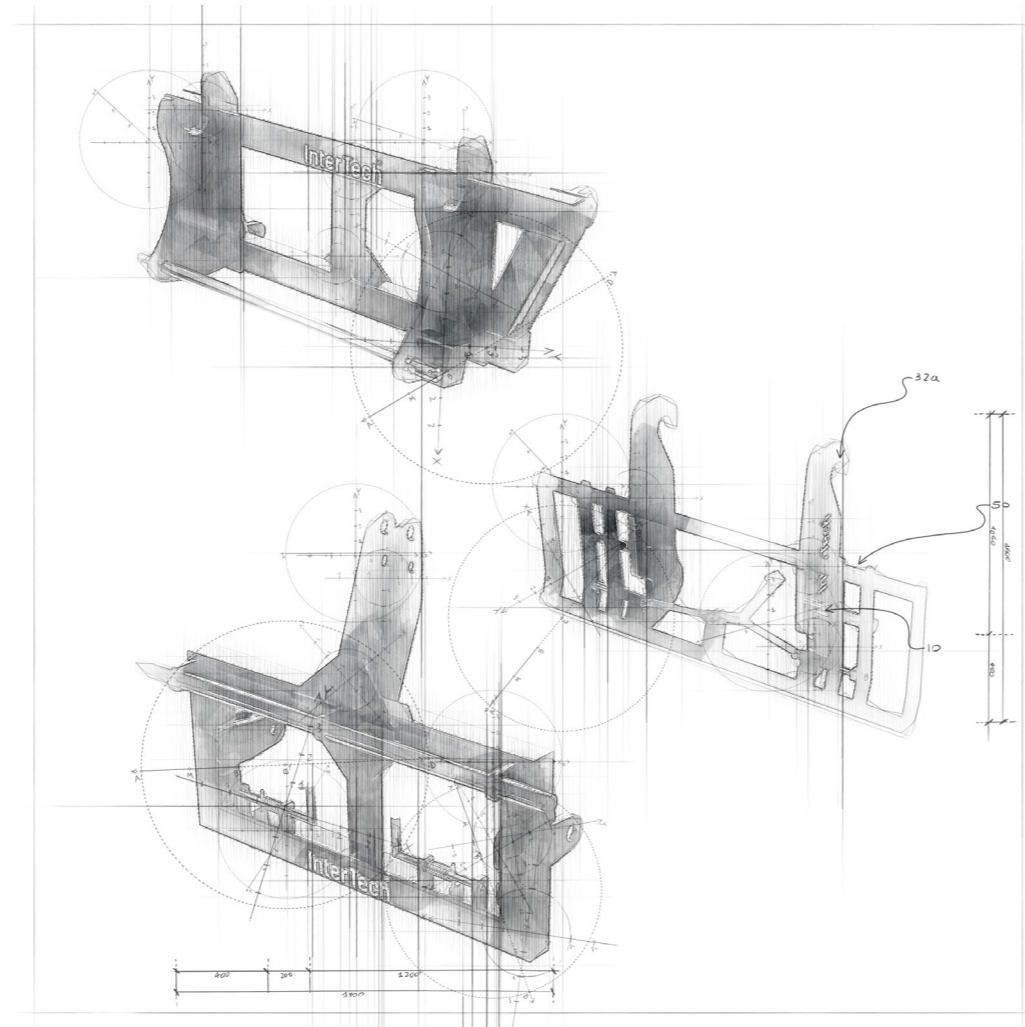

SMART
line

REDUCTION

Machine no	S106
Front loader <-> Front loader (PLN)	●
Front loader <-> Telehandler (PLN)	●
Front loader <-> Skid steer loader (PLN)	●
Telehandler <-> Telehandler (PLN)	●
Telehandler <-> Skid steer loader (PLN)	●
Skid steer loader <-> Skid steer loader (PLN)	●

- ✓ Standard equipment
- Optional equipment
- Option not available
- Recommended
- Especially recommended

REMAINING EQUIPMENT



The excavator arm has a solid, steel construction that allows to perform earthworks. It is intended for use on mini loaders.

The manure scraper, on the other hand, facilitates maintaining cleanliness in the barn and reduces working time thanks to its wide working width.

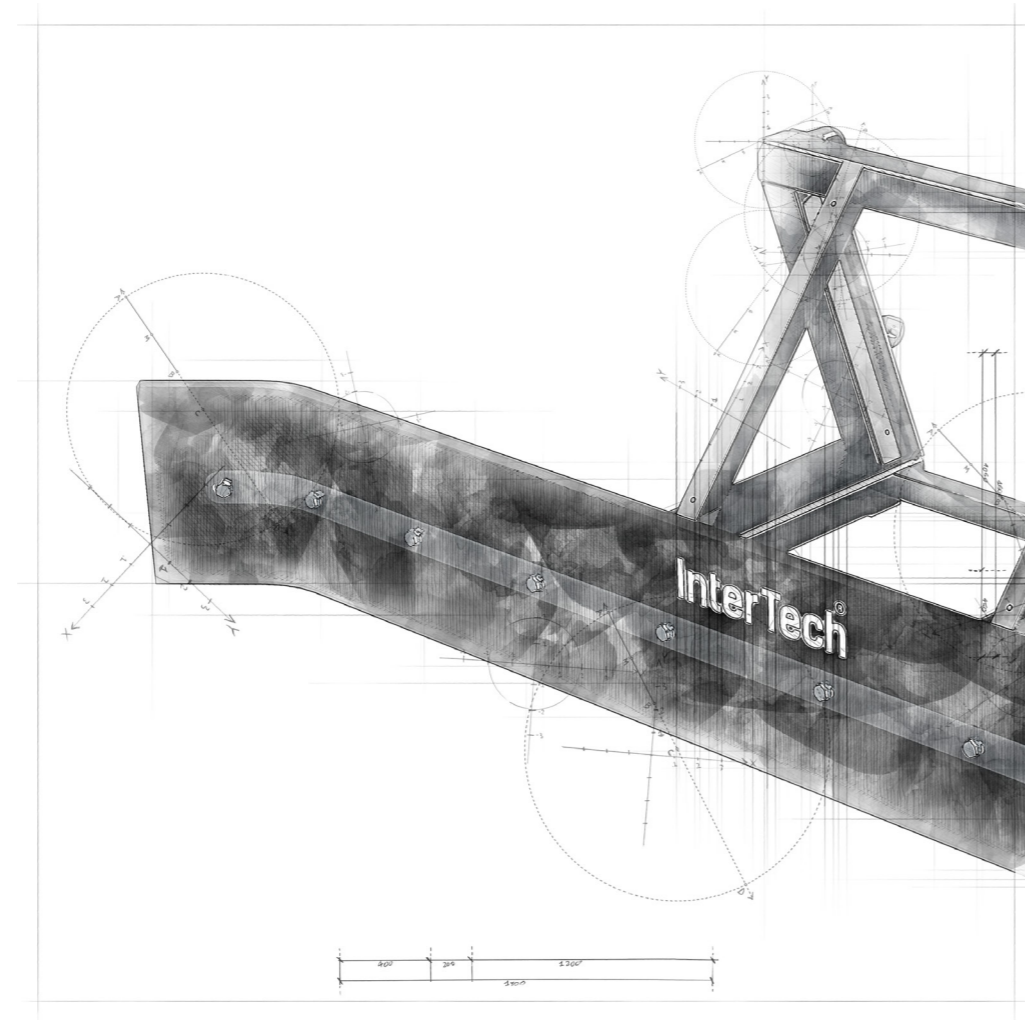

MANURE SCRAPER

Machine no	SI01	SI02
Width (m)	2,6	3,0
Height (m)	0,4	0,4
Weight (kg)	120	144
Equipment		
EURO or SMS connection lub TUZ kat. II	✓	✓
Telehandler mount (PLN)	●	●
Skid steer mount (PLN)	●	●
EURO/TUZ connection (PLN)	●	●
Service package (PLN)	●●	●●



AV EXCAVATOR ARM

Machine no	SI04	SI05
Bucket width (cm)	25	40
Digging depth (m)	1,4	1,4
Weight (kg)	110	120
Equipment		
EURO or SMS connection	—	—
Telehandler mount	—	—
Skid steer mount (PLN)	✓	✓
Service package (PLN)	●●	●●

SMART
line

- ✓ Standard equipment
- Optional equipment
- Option not available
- Recommended
- Especially recommended



interitech



GUARANTEE

We guarantee a professional service and professional advice. Every customer is important to us.



ENVIRONMENT

We use renewable energy sources.



TRANSPORT



We offer logistical support. Safe delivery of purchased machines.

www.itlogistic.pl



SAFETY

We build with your safety in mind.

work safely



SERVICE

Helpline service 24/7 Diagnosis, assistance and expert advice in case of any emergencies and questions regarding the use of the machines. We are there when you need us, whatever happens you have our support.

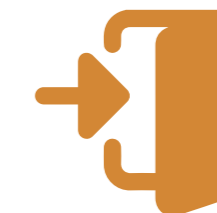

AVAILABILITY

Online at all times.

enova365



work safely

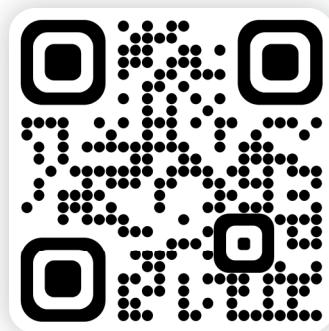

-  532 777 770
-  Aleja Wojska Polskiego 100,
18-300 Zambrów
-  facebook.com/InterTechZambrow
-  [intertech_agro](https://instagram.com/intertech_agro)
-  [InterTechAgro](https://www.youtube.com/InterTechAgro)
-  sekretariat@intertech-agro.pl
-  www.intertech-agro.pl